

ORIGINAL RESEARCH

Cascaded deep NN-based customer participation by considering renewable energy sources for congestion management in deregulated power markets

Anjali Agrawal¹ | Pratima Walde² | Seema N. Pandey³ | Laxmi Srivastava⁴ |
R. K. Saket⁵ | Baseem Khan⁶ 

¹Department of Electrical and Electronics Engineering, Noida Institute of Engineering and Technology, Greater Noida, India

²Department of Electrical, Electronics and Communication Engineering, Sharda University, Greater Noida, India

³Department of Electrical Engineering, Dr. Bhim Rao Ambedkar Polytechnic College, Gwalior, India

⁴Department of Electrical Engineering, Madhav Institute of Technology and Science, Gwalior, India

⁵Department of Electrical Engineering, Indian Institute of Technology (BHU), Varanasi, UP, India

⁶Department of Electrical and Computer Engineering, Hawassa University, Hawassa, Ethiopia

Correspondence

Baseem Khan, Department of Electrical and Computer Engineering, Hawassa University, Hawassa, Ethiopia.

Email: baseem_khan04@yahoo.com

Abstract

Continuously varying loading conditions and the cost-based operation of a competitive power market lead to the problem of congestion as one of the most crucial issues. In day-ahead power market operation (PMO), customer participation (CP) and generation rescheduling (GR) are the most effective techniques preferred by the system operator to eliminate congestion. In this paper, a cascaded Deep Neural Network (DNN) module has been presented for estimating customer participation and power generated by Wind Energy Source (WES) as on-site generation (OSG) to manage congestion. The proposed module is a cascade combination of Artificial Neural Network (ANN) as a filtering module (FM) and DNN as a congestion management (CM) module. The CM module estimates the customer participation for all receptive customers, power supplied by wind energy sources under uncertain conditions and generation rescheduling of all generators with minimum cost for all unseen congested power system loading patterns. The proposed CM approach provides an instant and efficient solution to manage congestion with minimum cost. The developed module has been examined on IEEE 30-bus power system. The maximum error found in the testing phase is 1.1865% which is very less and within the acceptable limit.

1 | INTRODUCTION

In a competitive power market, participants try to get electricity from the cheapest available source. This tendency sometimes causes the transmission networks to operate beyond transfer limits and the system is said to be congested. Congestion management (CM) is supposed to be the most crucial issue of a restructured power system. A comprehensive summary of CM methods has been proposed by [1]. Congestion can be effectively eliminated through several methods either by demand side management (DSM) or by generation side management. Generation side management includes generation rescheduling (GR) [2, 3]. In a newly developed power market environment as the load is supposed to be the cause of congestion, DSM is proving itself as a promising tool for congestion management

[4]. DSM is the method to modify the customer's demands either by CP or by their behavioural changes through education, that is, energy efficiency (EE) [5]. Through financial incentive-based CP, receptive customers take part in power system operation and modify their demands to manage congestion [6]. However, the reduction of demand opposes the theme of the business model of any commodity market which requires more and more consumption. Load reduction accomplished by CP has to be restricted in order to avoid customer dissatisfaction. So, in order to limit the customer participation amount, on-site generation has to be added for managing congestion [7, 8]. Thus, targeted DSM along with on-site generation can be an effective alternative to congestion management [9]. Due to several advantages such as cost-effectiveness, clean energy source, renewable energy source [10, 11], no toxins, no pollution, less

This is an open access article under the terms of the [Creative Commons Attribution](https://creativecommons.org/licenses/by/4.0/) License, which permits use, distribution and reproduction in any medium, provided the original work is properly cited.

© 2023 The Authors. *IET Renewable Power Generation* published by John Wiley & Sons Ltd on behalf of The Institution of Engineering and Technology.

TABLE 1 Comparison of proposed CM approach with the reported methods

Reported methodology	Congestion control scheme	Advantages	Disadvantages	Reference
Rider optimization	GR	Minimize rescheduling cost	EA based optimization	[2]
PSO	GR	Bid based generators rescheduling	EA based optimization	[3]
Random drift-PSO	CP	Incentive based CP	EA based optimization	[6]
Differential Evolution	DG	CM with renewable energy source	EA based optimization	[7]
Flower Pollination	DG	CM with renewable energy source	EA based optimization	[8]
GAMS and CPLEX software	CP	Real time-based pricing	EA based optimization	[9]
Q-learning algorithm	DG	Social welfare maximization	EA based optimization	[11]
Artificial bee colony	Wind energy source	Sensitivity based Wind placement	EA based optimization	[12]
GAMS software	DR	CM with renewable energy source	EA based optimization	[15]
MOPSO	DRP	2-objective functions	EA based optimization	[16]
MATPOWER (Matlab)	TCSC placement	CM with renewable energy source	EA based optimization	[17]
Jaya Algorithm	Transmission switching / DR	Hybrid power system	EA based optimization	[18]
Cascaded Deep NN [Proposed]	CP/WES/GR	Instant / ready CM	–	[Proposed]

maintenance cost etc. [12] wind energy source has proven to be the most preferable on-site generation plant nowadays, it reduces the carbon emission as well [13]. However, continuously changing wind velocity imparts uncertainty in the power output of wind energy sources [14], which has to be taken into account while expecting scheduled output from WES as on-site generation [15].

In the literature, several evolutionary algorithms (EA) have been suggested for optimizing control parameters to manage congestion [16–18]. A comparison of evolutionary techniques-based CM has been presented in Table 1.

The optimum solutions obtained by these evolutionary algorithms are always affected by the selection of initial parameters, number of generations, population size and many other parameters [19–21]. During the exploitation phase of many evolutionary algorithms, rejection of low fitness solutions for achieving global best may result in loss of optimal solution. As well as for each loading condition (minor changes) simulation starts from the initial phase which may lead to sluggish performance of these algorithms. Presently increasing loading scenarios and the competitive environment of the emerging power market have made its operation very complex and tedious. To overcome this situation, a quick and efficient solution is required and Deep NN has been found suitable for this purpose. Deep NN contains multiple hidden layers. Parameter sharing, sub-sampling and sparse connectivity of adjacent layers reduce the number of learning parameters and learning time during the training phase. Therefore, makes the estimation performance of Deep NN very fast even for large data sizes [22]. Such type of extreme features of Deep NN has attracted the focus of researchers. In the field of power system Deep NN have been found for estimating generation rescheduling [23], photovoltaic power [24, 25], wind speed [26] and Locational marginal price [27] etc. Deep NN has also been suggested for residential customer participation in smart grids [28, 29].

To the best of the authors' knowledge, a cascaded Deep NN-based CM approach by employing customer participation and wind energy source as on-site generation has not been found in the literature. The proposed Deep NN is a cascade combination of the filtering module (ANN) and the CM module (Deep NN). The filtering module, which is trained by a modified back propagation algorithm, filters out the congested and non-congested power system loading patterns exactly in two classes. CM module is a Deep NN and estimates the customer participation for receptive customers, generation rescheduling for generators and wind energy source as on-site generation for all unseen congested power system loading patterns to manage congestion. For creating actual power market scenarios, the power system loading patterns have been generated by perturbing $\pm 10\%$ load at all load buses and congestion has been managed by Deep NN-based CP, GR and WES. The cascaded Deep NN has been examined on IEEE 30-bus system [16].

The main contribution of the paper is as follows:

- This paper proposes an instant-ready solution for CM in deregulated market by employing customer participation considering wind energy sources.
- The cascaded Deep NN is a combination of the filtering module and CM module.
- The filtering module is an artificial neural network, trained by a modified back propagation algorithm and filters out successfully congested and non-congested loading patterns for an imbalanced data set.
- CM module is a Deep NN which estimates customer participation, generation rescheduling and active power supplied by wind energy sources accurately and instantly for all unseen power system loading patterns.
- Uncertainty of wind energy sources has also been considered and modelled with the Weibull distribution function.
- The presented Deep NN mitigates congestion efficiently and provides operating flexibility for the system operator.

This paper consists of the following sections: In the second section, problem formulation with different objective functions and constraints has been presented. In the third section, a brief description of the developed cascaded Deep NN has been given. In the fourth section proposed research methodology of this work has been discussed. In the fifth section, the proposed approach has been demonstrated on IEEE 30-bus system. In the sixth section conclusion of the paper is discussed.

2 | PROBLEM FORMULATION

Here, CM has been framed as an operational cost minimization problem subject to various equality and inequality constraints and operational cost consists of conventional generation cost, CP cost and OSG cost. Any optimization technique may be preferred for optimal power flow (OPF). Particle swarm optimization (PSO) is the well-accepted population-based optimization algorithm that has been suggested for CM [16], hence it has been used here for the minimization of cost. The objective function has been modelled as follows:

2.1 | Objective function

Here, along with operational cost, demand reduction by receptive customers has also been minimized. Similarly, OSG cost minimization has been accompanied by optimizing the size and site of WES. The objective function and constraints are given as follows: Components of overall operational cost can be formulated as follows:

2.1.1 | Conventional generation cost

Conventional generation cost C_G (\$/h) has been computed using quadratic cost function as:

$$C_G = \sum_{i=1}^{N_G} (a_i + b_i P_{G_i} + c_i P_{G_i}^2) \quad i = 1, 2, 3, \dots, N_G \quad (1)$$

where P_{G_i} is the real power generated by i th generating unit, a_i , b_i and c_i are the cost coefficients of i th generating unit and N_G is the total number of generators.

2.1.2 | Cost of wind energy source

The cost of WES, that is, C_{WES} (\$/h) can be expressed as follows [17]:

$$C_{WES} = \psi \times P_{WES} \quad (2)$$

where ψ is the cost of WES in \$/MW h, P_{WES} is the real power output in MW of wind energy source and is given as follows [17]:

$$P_{WES} = \frac{1}{2} \text{air}_{density} \times W_t \times \eta_{WES} \times v_w^3 \quad (3)$$

The power output of WES is quite uncertain due to the continuously varying speed of wind at any specific location. Hence, the variable wind speed has to be taken into account for the computing power output of WES. The Weibull probability density function (PDF) [18] has been explored to estimate wind speed within certain bounded limits and can be modelled as follows [18]:

$$f(v_w) = \left(\frac{b}{s}\right) \times \left(\frac{v_w}{s}\right)^{b-1} \times \exp\left[-\left(\frac{v_w}{s}\right)^b\right] \quad 0 < v_w < \infty \quad (4)$$

where v_w is wind speed, s is the wind velocity multiplying factor and b is the shape factor of WES. Thus, by considering the shape of the wind wave and velocity scaling the wind speed can be maintained within desirable limits. Consequently, WES output can be obtained within zero and rated values. The desired values of b and s should normally be greater than zero. According to wind velocity, the wind power output can be expressed as follows [18]:

$$P_{WES} = \begin{cases} 0 & v_w < v_{w_i} \text{ and } v_{w_r} \\ P_{WES}^{rated} \left(\frac{v_w - v_{w_i}}{v_{w_r} - v_{w_i}}\right) & v_{w_i} \leq v_w \leq v_{w_r} \\ P_{WES}^{rated} & v_{w_r} \leq v_w \leq v_{w_c} \end{cases} \quad (5)$$

where v_{w_i} is the cut-in wind speed, v_{w_r} is the rated wind speed, and v_{w_c} is the cut-off speed of the wind. Equation (5) reveals that rated power output from WES can only be obtained when wind speed varies between rated and cut-off speed. The expression for Weibull PDF to model uncertain power output of WES can be given as [18]:

$$f(P_{WES}) = b \left(\frac{v_{w_r} - v_{w_i}}{s^b \times P_{WES}^{rated}}\right) \times \left[v_{w_i} + \frac{P_{WES}}{P_{WES}^{rated}} (v_{w_r} - v_{w_i}) \right] \times \exp\left[-\left(\frac{v_{w_i} + \frac{P_{WES}}{P_{WES}^{rated}} (v_{w_r} - v_{w_i})}{s}\right)^b\right] \quad (6)$$

2.1.3 | Customer participation cost

For managing congestion under CPP customer participation cost C_{CP} (\$/h) can be written as follows [16]:

$$C_{CP} = \sum_{j=1}^{N_{CP}} \mu_j \quad (7)$$

where μ_j (\$/h) is the CPP cost for j th receptive customer and N_{CP} is the total number of receptive customers and $N_{CP} \in N_{LB}$, where N_{LB} is the total number of load buses. Incentive (μ_j) in \$/h paid to the j th receptive customer can be given as follows [16]:

$$\mu_j = INC \times (d_{0_j} - d_j) \quad (8)$$

where INC is the incentive paid to the customer in \$/MW h, d_{0_j} is the initial demand, that is, the demand of j th receptive customer before getting involved in CPP and d_j is the reduced demand, that is, demand of customer after being involved in CPP.

The demand of j th receptive customer d_j can be hypothetically expressed as follows [16]:

$$d_j = d_{0_j} \times [1 + \epsilon \times \left\{ \frac{(EP_{CP} - EP_0) + (INC - PEN)}{EP_0} \right\}] \quad (9)$$

where EP_0 and EP_{CP} are the electricity prices in \$/h before and after CPP, ϵ denotes the self-elasticity of customer's demand and PEN is the penalty imposed on defaulter customers in \$/MW h which is considered to be zero here.

Finally, the operational cost function to be minimized can be written as follows:

$$F = \text{minimize} \{C_G + C_{CP} + C_{WES}\} \quad (10)$$

2.2 | Constraints of CM problem

In the present work, the equality and inequality constraints which are involved during the optimization process are as follows:

2.2.1 | Equality constraints

Power balance equations contribute to the equality constraints. These can be expressed as follows:

$$\sum_{i=1}^{N_G} P_{G_i} - \sum_{j=1}^{N_{LB}} P_{D_j} - P_L = 0 \quad (11)$$

$$\sum_{i=1}^{N_G} Q_{G_i} - \sum_{j=1}^{N_{LB}} Q_{D_j} - Q_L = 0 \quad (12)$$

where P_{G_i} and Q_{G_i} are the active and reactive power generation at i th bus respectively, P_{D_j} and Q_{D_j} are the active and reactive power demands at j th bus respectively, P_L and Q_L are the total active and reactive power losses respectively.

2.2.2 | Inequality constraints

Power system operational and security constraints which are to be kept within certain operational limits have been considered as inequality constraints. These can be listed as follows:

a. Generation constraints: Generator voltage V_G , active power P_G and reactive power Q_G have been kept restricted within their upper and lower limits, as follows:

$$P_{G_i}^{min} \leq P_{G_i} \leq P_{G_i}^{max} \quad i = 1, 2, 3 \dots \dots N_G \quad (13)$$

$$Q_{G_i}^{min} \leq Q_{G_i} \leq Q_{G_i}^{max} \quad i = 1, 2, 3 \dots \dots N_G \quad (14)$$

$$V_{G_i}^{min} \leq V_{G_i} \leq V_{G_i}^{max} \quad i = 1, 2, 3 \dots \dots N_G \quad (15)$$

b. Security constraints: Maximum and minimum voltage limits at all the load buses and maximum thermal limit over transmission lines have been included as security constraints. These are given as follows:

$$V_k^{min} \leq V_k \leq V_k^{Max} \quad k = 1, 2, 3 \dots \dots \dots N_{LB} \quad (16)$$

$$S_{max_l} \geq S_l \quad l = 1, 2, 3 \dots \dots \dots N_{BR} \quad (17)$$

where S_{max_l} is the maximum thermal limit over l th line in MVA, S_l is the apparent flow over l th line in MVA.

c. Customer participation constraints:

CPP cost μ_j must be bounded within lower and upper limits. Similarly, the amount of CP has to be kept restricted to avoid any kind of customer dissatisfaction. These limits must be mentioned in a financial contract framed by ISO. This can be written as follows:

$$\mu_j^{min} \leq \mu_j \leq \mu_j^{max} \quad j = 1, 2, 3 \dots \dots N_{CP} \quad (18)$$

$$CP_j^{min} \leq CP_j \leq CP_j^{max} \quad j = 1, 2, 3 \dots \dots N_{CP} \quad (19)$$

where CP_j is the amount of customer participation for j th receptive customer.

a. On-site generation constraints:

The amount of active power supplied by WES in the role of on-site generation is bounded within upper and lower limits, given as follows:

$$P_{WES}^{min} \leq P_{WES} \leq P_{WES}^{max} \quad (20)$$

3 | CASCADED DEEP NEURAL NETWORK

The developed module is a cascade combination of back propagation-based ANN and Deep NN and has been proposed for congestion management by reducing the demand under CPP and by employing WES as OSG in the deregulated power market. The basic architecture of the filtering module and congestion management module can be given as follows:

3.1 | FILTERING MODULE

The proposed filter module filters out the congested and non-congested PSLP in two separate classes. It is a modified back propagation algorithm-based Feed-Forward multi-layer ANN [30]. The architectural diagram of the filtering module has been shown in Figure 1. This module gives a single output for each PSLP. In the case of congested PSLP, it shows 0.9 (high actual output) and 0.1 (low actual output) for non-congested PSLP. The training set data of this ANN holds an unequal number of epitomes for the dominance class (higher), that is, congested power system loading patterns (CPSLP) and for the subordinate class (lower), that is, non-congested power system loading patterns (NCPSLP). Such a type of training data set is termed as an imbalance training data set [31].

For this type of imbalance training set the rate of convergence of net output error is very low when ANN-based filtering module is trained by a standard back propagation algorithm that leads to higher error in subordinate classes as shown in Figure 2.

To reduce this error, the ANN-based filtering module is trained by a modified back propagation algorithm [30, 31]. This computes a descent vector μ in weight space, for each iteration. This descent vector μ points the gradient vector in a downhill direction for both dominance as well as subordinate class and satisfies Equation (21) and weights are modified according to Equation (22).

$$-\mu \cdot \nabla E_1(W) < 0 \quad \text{and} \quad -\mu \cdot \nabla E_2(W) < 0 \quad (21)$$

$$W(k+1) = W(k) - \tau \mu \quad (22)$$

where $W(k+1)$ and $W(k)$ are the weights in $(k+1)$ th and k th iteration, τ is the learning rate.

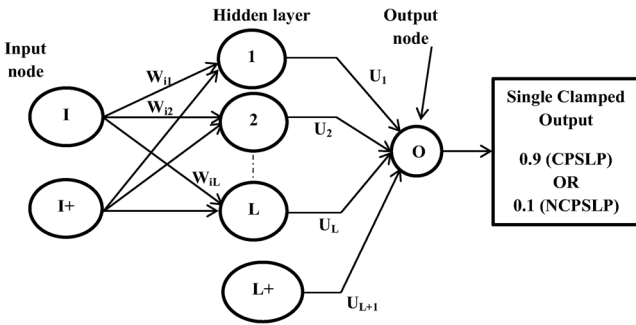

FIGURE 1 Architecture of filtering ANN module

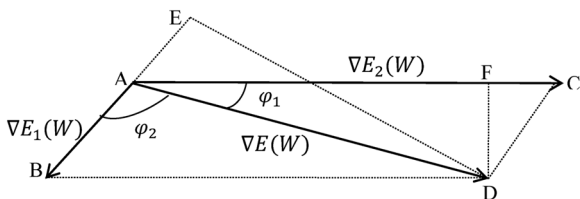

FIGURE 2 Relationship between the gradient error vectors

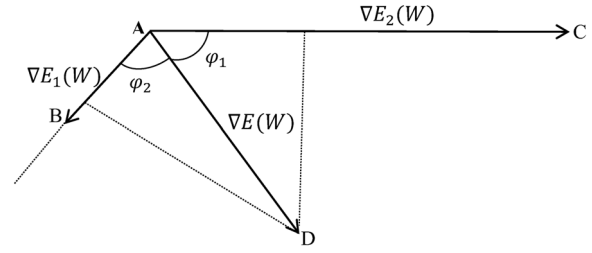

FIGURE 3 Directions of gradient error vectors in modified BP algorithm

The magnitude of the descent vector μ can be determined by using Equation (23).

$$\mu = \nabla E_K(W) + \nabla E_{K-}(W) \quad (23)$$

where $E_1(W)$ and $E_2(W)$ represent the error due to dominance and subordinate class. In this way, by using a modified BP algorithm the error for both classes reduces appropriately.

This is shown in Figure 3 that the direction of vector μ is decided to bisect the angle between $-\nabla E_1(W)$ and $-\nabla E_2(W)$ as follows [31]:

$$\frac{-\nabla E_1(W)}{-\nabla E_1(W)} \mu = \text{frac} \frac{-\nabla E_2(W) - \nabla E_2(W)}{-\nabla E_1(W)} \mu \quad (24)$$

Therefore, for the imbalance training data set the rate of learning has been accelerated by one order of magnitude as given in Equation (24) employing an adaptive learning rate.

3.2 | Deep neural network-congestion management module

The architecture of the developed Deep NN has been shown in Figure 4. This is a convolution-based Deep NN and estimates the CP, GR and power of WES under uncertainty. Deep learning-based MATLAB toolbox has been employed for the proposed Deep NN. Convolution-based Deep NN consists of many hidden layers unlike conventional ANN and is applicable for image data. Classification and estimation (for continuously varying data) tasks can be effectively performed by CNN-based Deep NN. In developed Deep NN estimates CP, GR and active power of WES for continuously changing power system loading patterns. The proposed Deep NN contains six different kinds of layers. The input layer is the first one and receives input patterns in image formation only. The second layer which is the convolution layer performs the convolution operation between input image signals and kernel filters. It may be multi-dimension but in this case, its dimension is 2D. Sparse connectivity of adjacent layers, sub-sampling and parameter sharing properties of these layers reduces the dimension of learning parameters and make the Deep NN faster. The batch normalization layer is the third layer which standardizes the input pattern set and reduces the epochs and finally improves the performance and reduces the learning time of Deep NN. ReLu layer, that is, a fourth layer termed as the rectified linear unit has been applied as an activa-

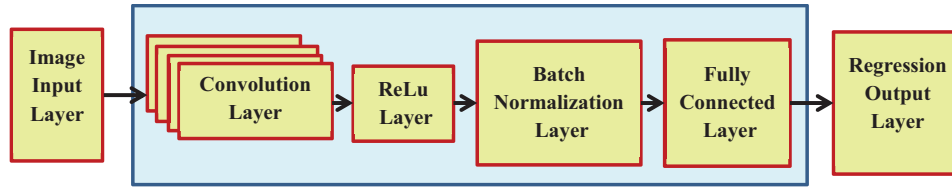

FIGURE 4 Architecture of Deep Neural Network

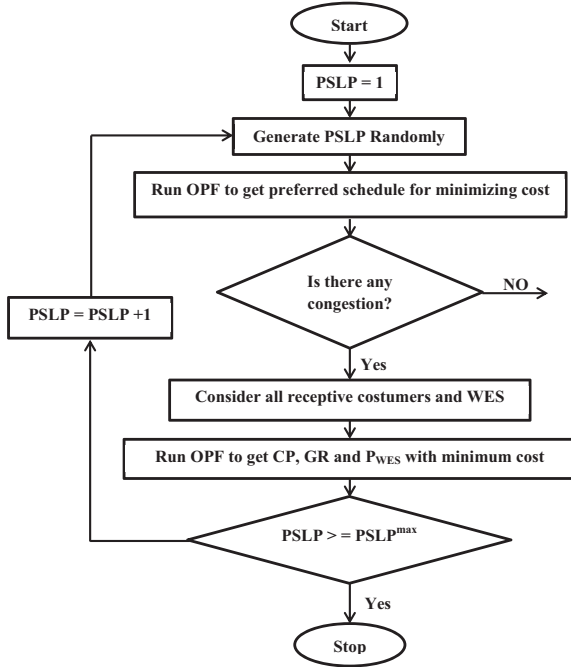

FIGURE 5 Steps for generating PSLP

where y_i and \hat{y}_i are the actual output and predicted outputs for the pattern set of I size.

4 | RESEARCH METHODOLOGY

Cascaded Deep NN provides the instant-ready solution for continuously varying loading patterns in the power system to manage congestion. For training and testing of the proposed model with a realistic power system situation, power system loading patterns have been generated by varying the active and reactive power system load. The steps for generating these power system loading patterns have been systemically shown in Figure 5

The proposed research methodology for the congestion management approach has been shown in Figure 6. In the present approach, a cascade combination of ANN-based filtering module and a Deep NN-based CM module has been developed. The filtering module is a feed-forward ANN which is trained by a modified back propagation algorithm while the CM Module is a Deep NN. Several power system loading patterns have been generated and given to the filtering module, which filters out the congested power system loading patterns

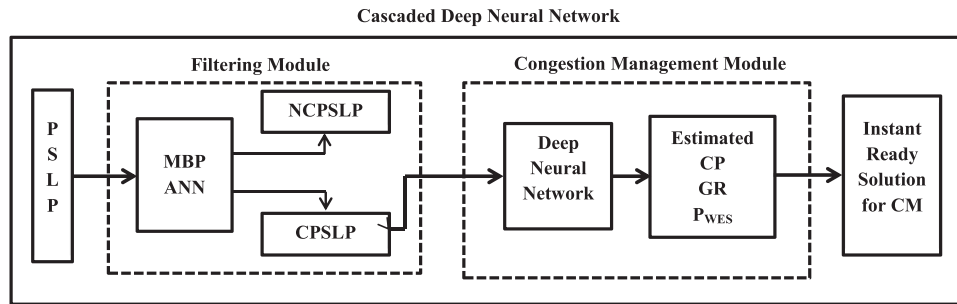

FIGURE 6 Schematic diagram of proposed research methodology for CM

tion function. A fully connected layer is the second last and fifth layer while the final output (sixth) layer is the regression output layer which estimates output continuously. The endmost output of the Deep NN is to minimize the loss function. In the present work, a root mean square error has been considered as a loss function and can be presented as follows [24]:

$$\text{RMSE} = \sqrt{\frac{\sum_{i=1}^I (y_i - \hat{y}_i)^2}{I}} \quad (25)$$

(CPSLP) and non-congested power system loading patterns (NCPSLP). Only CPSLP have been applied to the Deep NN as input. Deep NN has been trained to predict CP, GR and P_{WES} for continuously varying power system loading patterns as actual output (regression) which is very close to actual output. Thus, the developed Deep NN predicts CP for all receptive costumers, generation rescheduling for all conventional generators and active power generated by WES under uncertainty as output with minimum cost. Hence, by relieving the congestion

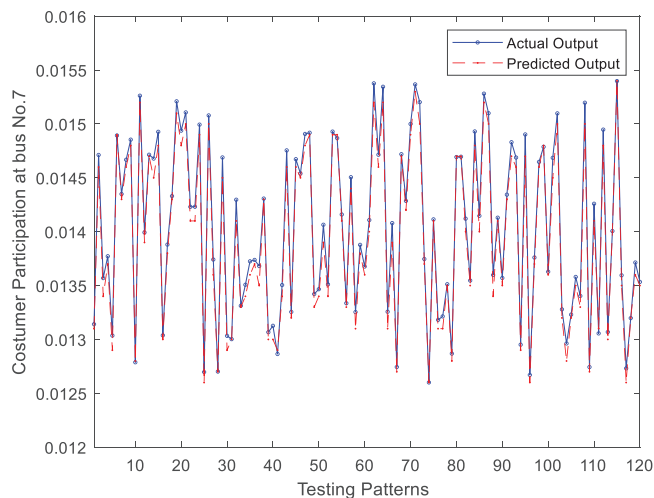

FIGURE 7 Actual and predicted output of deep NN for CP at bus number 7

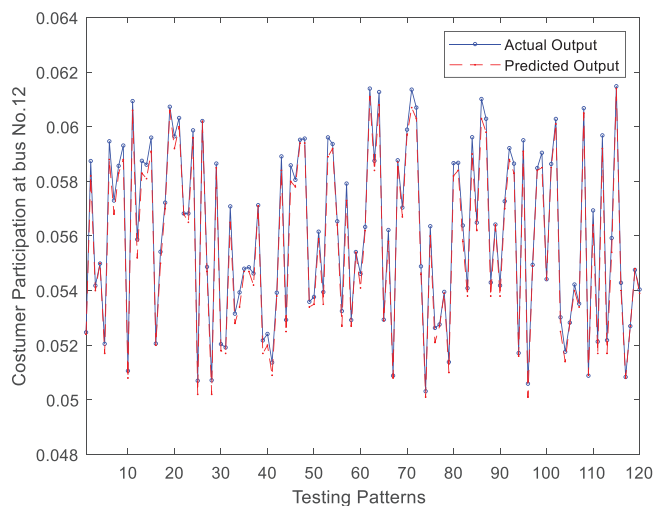

FIGURE 9 Actual and predicted output of deep NN for CP at bus number 12

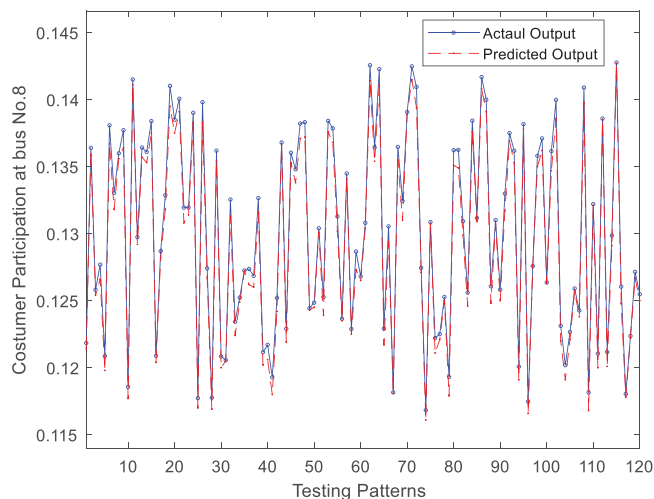

FIGURE 8 Actual and predicted output of deep NN for CP at bus number 8

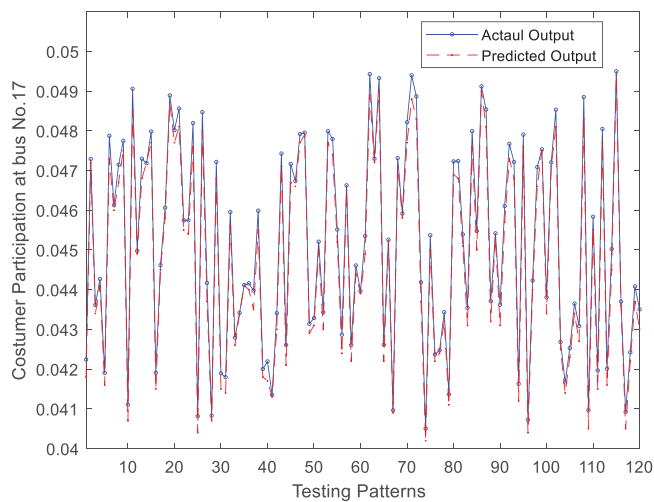

FIGURE 10 Actual and predicted output of deep NN for CP at bus number 17

of transmission lines the proposed method provides an instant-ready solution for the system operator to operate deregulated power market.

5 | RESULTS AND DISCUSSION

Here, the problem of congestion has been handled by employing cascaded Deep NN which estimates customer participation, generation rescheduling and wind energy source (under uncertainty) to manage congestion. The developed model has been examined on IEEE 30-bus system [16]. This bus system comprises six generator buses (numbered as bus no. 1, 2, 13, 22, 23 and 27), 24 load buses (21 non-zero load buses) and 41 transmission lines. Simulations have been carried out by using the Matlab platform.

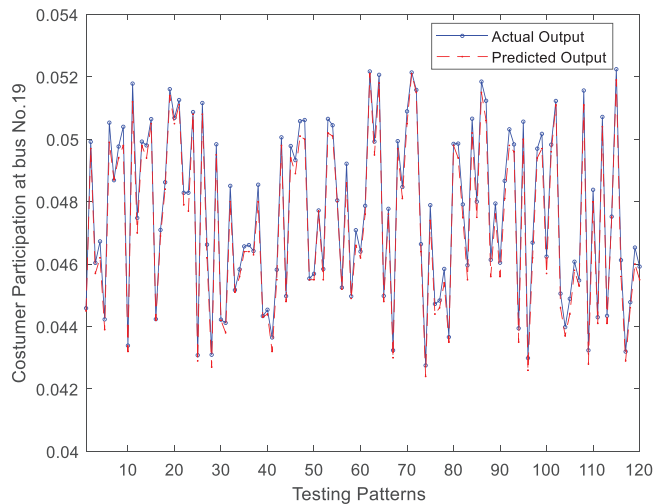

FIGURE 11 Actual and predicted output of deep NN for CP at bus number 19

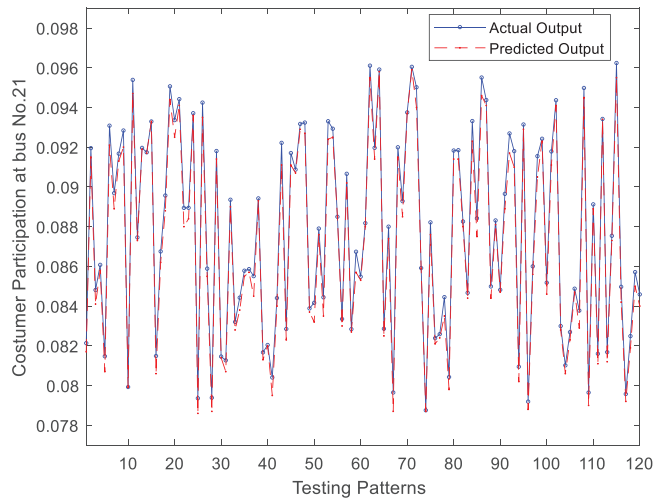

FIGURE 12 Actual and predicted output of deep NN for CP at bus number 21

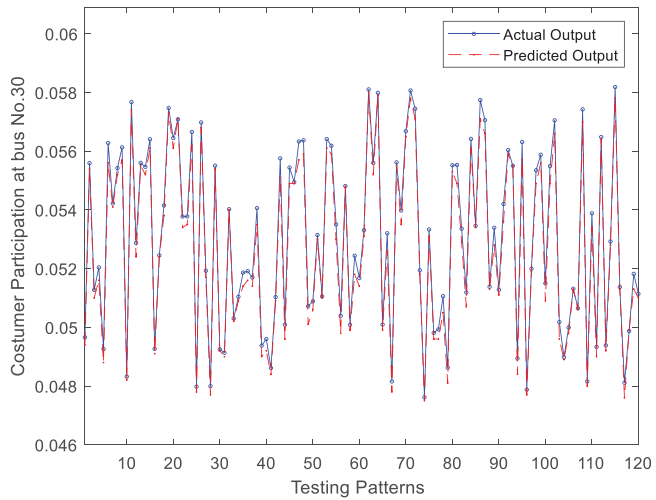

FIGURE 13 Actual and predicted output of deep NN for CP at bus number 30

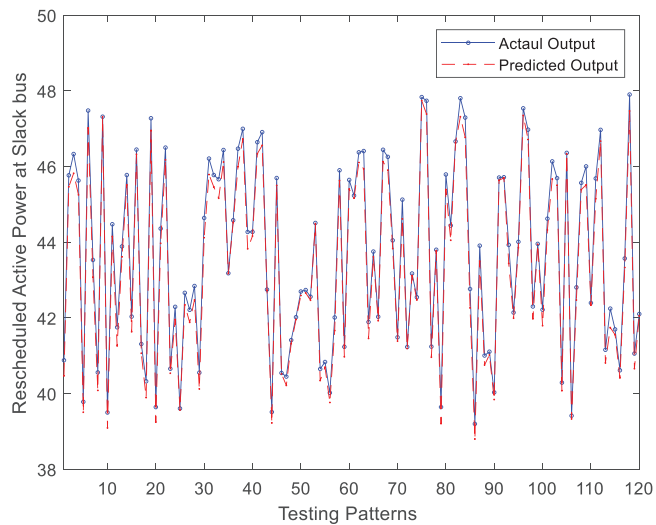

FIGURE 14 Actual and predicted output of deep NN for GR at slack bus

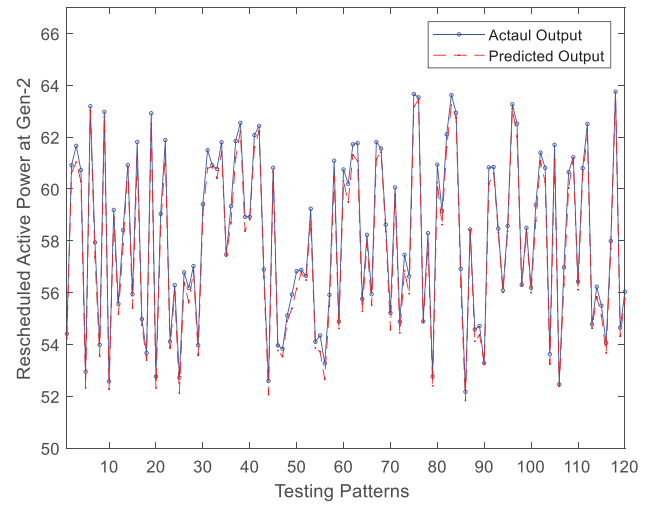

FIGURE 15 Actual and predicted output of deep NN for GR at generator 2

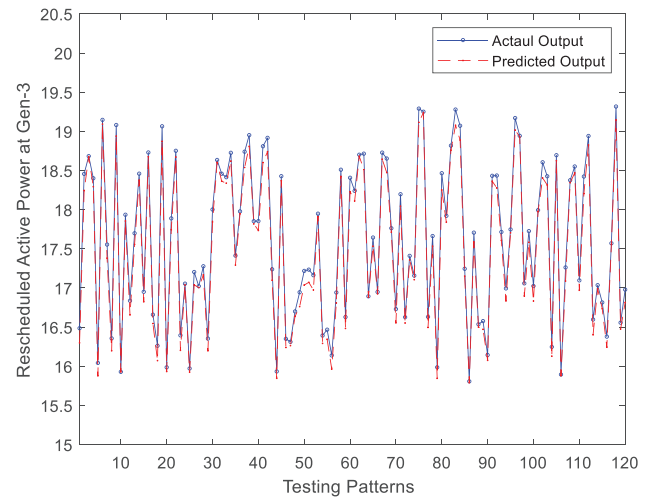

FIGURE 16 Actual and predicted output of deep NN for GR at generator 3

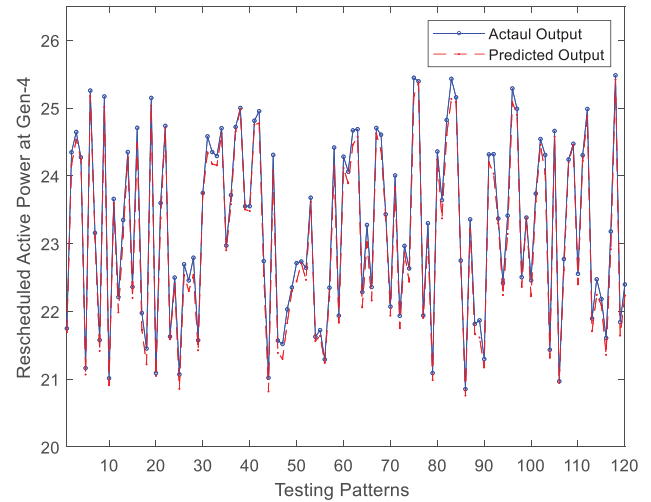

FIGURE 17 Actual and predicted output of deep NN for GR at generator 4

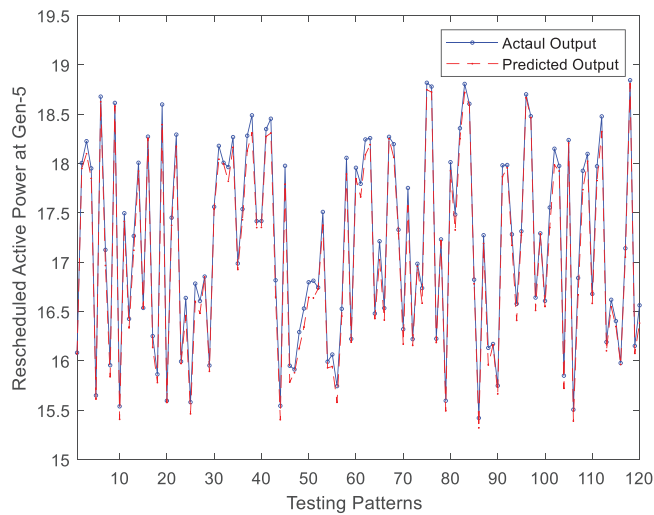

FIGURE 18 Actual and predicted output of deep NN for GR at generator 5

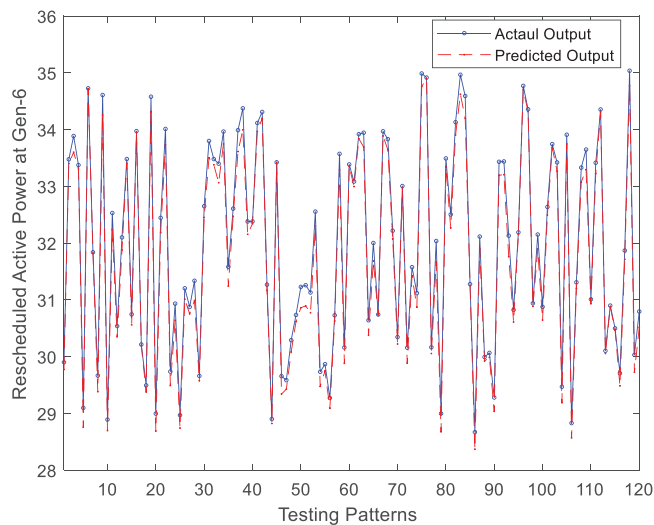

FIGURE 19 Actual and predicted output of deep NN for GR at generator 6

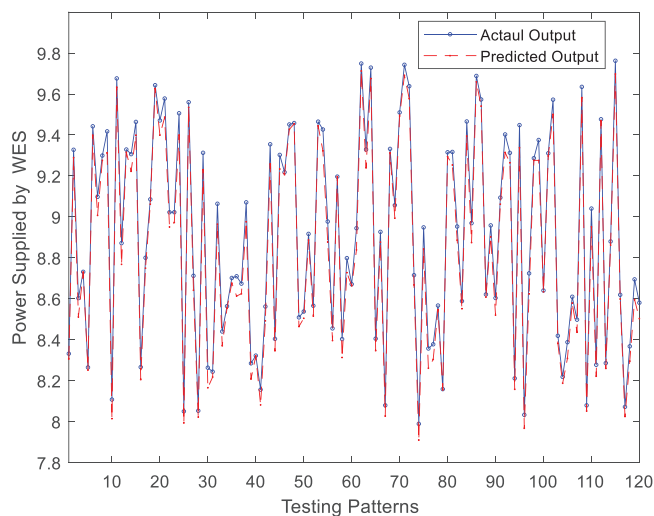

FIGURE 20 Actual and predicted output of deep NN for P_{WES}

Continuously varying power system loading patterns have been generated by perturbing real and reactive demands $\pm 10\%$ (randomly) at all (21) non-zero load buses. Increased load creates congestion over transmission lines. In order to manage congestion, customer participation has been called through sensitivity analysis on load buses [32, 33]. As a result of this analysis, a total of seven buses numbered as 7, 8, 12, 17, 19, 21 and 30 have been determined for participating in the customer participation program. The maximum and minimum amount of demand reduction by a receptive customer has been taken within 0.1–10% of actual demand respectively. However, this amount in actual conditions depends upon the severity of the congestion. The electricity prices have been considered the same before and after CP.

The air density and overall efficiency of WES have been taken as 1.225 kg/m^3 and 49% respectively. The cost of WES has been assumed as $3.75\$/\text{MW h}$ [17]. For WES, the uncertainty of power output due to changeable wind velocity has been taken into account by considering the Weibull probability density function [18]. The maximum amount of power supplied by OSG has been taken as 10 MW. While implementing OSG, the optimum location of WES has been determined to be bus number 8.

After several trials, by considering the different architecture of cascaded Deep NN the best results have been found and given here. For creating a real power market scenario, 601 power system loading patterns have been generated by varying $\pm 10\%$ load at all 21 non-zero load buses. Out of 601 power system loading patterns only 470 loading patterns have been used to train and 130 loading patterns have been used to test the developed cascaded Deep NN.

Training of the filtering module (ANN) has been accomplished by the modified back propagation algorithm to filter out the congested and non-congested power system loading patterns accurately. In the training phase, out of 470 power system loading patterns, 454 loading patterns have been filtered as congested while 16 loading patterns have been classified as non-congested loading patterns. In the testing phase, out of 130 unseen power system loading patterns 120 loading patterns have been filtered out as congested while the remaining 10 as non-congested loading patterns. The classification performance of the filtering module has been found accurate.

After several trials, the optimum size of various layers for Deep NN has been determined and implemented here. Inputs for this CM module (Deep NN) are the active power load (21), reactive power load (21) and apparent power load (21). Hence, the size of the input layer has been taken as $3 \times 21 \times 1$ (63 inputs). Deep NN has been trained by 454 congested loading patterns (classified by filter module). During the testing phase, unseen 120 congested loading patterns (classified by filter module) have been given to Deep NN. The output of the Deep NN is the estimation of customer participation for all seven receptive costumers (bus no. 7, 8, 12, 17, 19, 21, 30), generation rescheduling for all conventional generators (bus no. 1, 2, 3, 4, 5, 6) and active power supplied by wind energy source (bus no. 8) under uncertainty with minimum cost. Thus a total of 14 predicted outputs (7 for customer participation,

TABLE 2 Actual output, predicted output and percentage error for customer participation

PSLP	Output	CP 7	CP 8	CP 12	CP 17	CP 19	CP 21	CP 30
1	Actual output	0.013142	0.121842	0.052473	0.042241	0.044588	0.082135	0.049657
	Predicted output	0.013100	0.121400	0.052400	0.041800	0.044500	0.081700	0.049400
	% Error	0.612700	0.346500	0.165800	1.001400	0.264700	0.579300	0.513500
2	Actual output	0.014712	0.136405	0.058744	0.047290	0.049917	0.091952	0.055592
	Predicted output	0.014600	0.135900	0.058200	0.047200	0.049700	0.091500	0.055400
	% Error	0.759000	0.345800	0.961300	0.271200	0.532500	0.482600	0.401300
3	Actual output	0.013570	0.125809	0.054181	0.043616	0.046039	0.084810	0.051273
	Predicted output	0.013400	0.125400	0.054000	0.043400	0.045700	0.084100	0.051000
	% Error	1.030200	0.291100	0.299800	0.507900	0.633700	0.871300	0.539100
4	Actual output	0.013772	0.127688	0.054990	0.044268	0.046727	0.086076	0.052039
	Predicted output	0.013700	0.126600	0.055000	0.044100	0.046200	0.085800	0.051600
	% Error	0.711500	0.835100	0.028900	0.436600	1.174200	0.355600	0.912900
5	Actual output	0.013036	0.120862	0.052051	0.041901	0.044229	0.081475	0.049258
	Predicted output	0.012900	0.119800	0.051700	0.041600	0.043900	0.080700	0.048800
	% Error	1.185200	0.918400	0.629200	0.825200	0.850500	0.956900	0.896000
6	Actual output	0.014893	0.138081	0.059466	0.047871	0.050531	0.093083	0.056275
	Predicted output	0.014900	0.136700	0.058800	0.047300	0.049900	0.092100	0.055600
	% Error	0.153200	0.975300	1.108400	1.119700	1.162000	1.083200	1.176600
7	Actual output	0.014350	0.133043	0.057297	0.046124	0.048687	0.089686	0.054222
	Predicted output	0.014300	0.131800	0.056800	0.046000	0.048700	0.088900	0.054100
	% Error	0.347800	0.955800	0.912100	0.258300	0.063700	0.907100	0.240800
8	Actual output	0.014668	0.135993	0.058567	0.047147	0.049766	0.091675	0.055424
	Predicted output	0.014600	0.135600	0.058300	0.046700	0.049400	0.091300	0.055200
	% Error	0.565400	0.300900	0.479900	0.892800	0.755100	0.396200	0.445100
9	Actual output	0.014854	0.137721	0.059311	0.047746	0.050399	0.092839	0.056128
	Predicted output	0.014800	0.136400	0.058800	0.047500	0.049800	0.092000	0.055700
	% Error	0.153600	0.949100	0.851000	0.616300	1.138600	0.852800	0.840200
10	Actual output	0.012788	0.118565	0.051062	0.041105	0.043389	0.079926	0.048321
	Predicted output	0.012800	0.117700	0.050800	0.040700	0.043200	0.079900	0.048200
	% Error	0.270500	0.746600	0.570700	0.901100	0.320000	0.039800	0.193800
11	Actual output	0.015262	0.141503	0.060940	0.049057	0.051783	0.095389	0.057669
	Predicted output	0.015200	0.141100	0.060600	0.048500	0.051200	0.094700	0.057400
	% Error	0.214700	0.274500	0.523100	1.044400	1.125600	0.729900	0.384100
12	Actual output	0.013993	0.129737	0.055873	0.044978	0.047477	0.087458	0.052874
	Predicted output	0.013900	0.129200	0.055200	0.044900	0.047000	0.087300	0.052400
	% Error	0.796700	0.451800	1.117300	0.281600	1.069700	0.133000	0.959200
13	Actual output	0.014714	0.136424	0.058753	0.047296	0.049924	0.091965	0.055599
	Predicted output	0.014700	0.135700	0.058300	0.046800	0.049800	0.091900	0.055500
	% Error	0.386300	0.537300	0.686200	1.114100	0.230800	0.060000	0.259600
14	Actual output	0.014679	0.136093	0.058610	0.047182	0.049803	0.091742	0.055465
	Predicted output	0.014500	0.135300	0.058100	0.047200	0.049400	0.091700	0.055200
	% Error	0.937300	0.593500	0.929000	0.032200	0.870200	0.065500	0.389300
15	Actual output	0.014927	0.138396	0.059602	0.047980	0.050646	0.093295	0.056403
	Predicted output	0.014800	0.137500	0.059100	0.047700	0.050500	0.093300	0.056100
	% Error	0.647400	0.640900	0.847500	0.665700	0.207300	0.031100	0.547700

(Continues)

TABLE 2 (Continued)

PSLP	Output	CP 7	CP 8	CP 12	CP 17	CP 19	CP 21	CP 30
16	Actual output	0.013038	0.120883	0.052060	0.041909	0.044237	0.081489	0.049266
	Predicted output	0.013000	0.120400	0.052000	0.041500	0.044200	0.080600	0.049100
	% Error	0.273300	0.409200	0.168600	1.055700	0.124700	1.132800	0.417700
17	Actual output	0.013880	0.128692	0.055423	0.044616	0.047094	0.086753	0.052448
	Predicted output	0.013800	0.128200	0.055000	0.044500	0.046900	0.086200	0.052400
	% Error	0.814200	0.345500	0.821500	0.198000	0.372400	0.622700	0.087200
18	Actual output	0.014331	0.132866	0.057220	0.046063	0.048622	0.089567	0.054150
	Predicted output	0.014300	0.131800	0.057000	0.045800	0.048400	0.088800	0.053800
	% Error	0.058200	0.834100	0.466700	0.504200	0.413500	0.896600	0.599000
19	Actual output	0.015210	0.141019	0.060732	0.048890	0.051606	0.095063	0.057472
	Predicted output	0.015100	0.139500	0.060600	0.048700	0.051400	0.094400	0.057300
	% Error	0.678900	1.107400	0.151500	0.387600	0.473000	0.699300	0.325100
20	Actual output	0.014938	0.138499	0.059646	0.048016	0.050683	0.093364	0.056445
	Predicted output	0.014800	0.137500	0.059200	0.047700	0.050500	0.092500	0.056100
	% Error	1.178200	0.704500	0.759900	0.672900	0.336600	0.876000	0.673000

TABLE 3 Actual output, predicted output and percentage error for generation rescheduling and P_{WES}

PSLP	Output	GEN1	GEN2	GEN3	GEN4	GEN5	GEN6	P_{WES}
1	Actual output	40.882249	54.409720	16.485874	21.747767	16.083459	29.902899	8.331784
	Predicted output	40.469900	54.222300	16.299800	21.692600	16.073100	29.775100	8.306200
	% Error	1.008605	0.344400	1.128800	0.253500	0.064500	0.427500	0.307600
2	Actual output	45.768770	60.913136	18.456377	24.347206	18.005862	33.477095	9.327655
	Predicted output	45.464600	60.622400	18.242800	24.160800	17.950400	33.401300	9.289400
	% Error	0.664599	0.477300	1.157000	0.765500	0.308300	0.226500	0.410000
3	Actual output	46.331261	61.661748	18.683202	24.646430	18.227151	33.888523	8.603082
	Predicted output	45.820600	61.031500	18.676400	24.535200	18.099800	33.601500	8.511000
	% Error	1.102144	1.022100	0.036700	0.451300	0.698400	0.847000	1.070500
4	Actual output	45.630585	60.729227	18.400653	24.273697	17.951499	33.376021	8.731544
	Predicted output	45.253700	60.286600	18.292900	24.243800	17.849400	33.305600	8.730200
	% Error	0.825969	0.728800	0.585500	0.123000	0.568800	0.210900	0.015100
5	Actual output	39.782884	52.946588	16.042552	21.162948	15.650959	29.098780	8.264834
	Predicted output	39.508000	52.324400	15.878500	21.068200	15.614100	28.758300	8.251900
	% Error	0.690957	1.175200	1.022800	0.447600	0.235500	1.170000	0.156800
6	Actual output	47.479218	63.189551	19.146119	25.257098	18.678768	34.728184	9.442290
	Predicted output	47.020200	63.036900	19.091000	25.178400	18.625800	34.721200	9.398800
	% Error	0.966735	0.241500	0.288000	0.311600	0.283400	0.020200	0.460100
7	Actual output	43.531495	57.935571	17.554189	23.157063	17.125697	31.840663	9.097764
	Predicted output	43.077800	57.367400	17.380600	23.090800	16.967300	31.825600	9.007100
	% Error	1.042159	0.980700	0.989100	0.286100	0.925000	0.047200	0.996600
8	Actual output	40.560552	53.981578	16.356149	21.576637	15.956901	29.667598	9.299492
	Predicted output	40.085000	53.549000	16.198400	21.417300	15.840100	29.384700	9.276000
	% Error	1.172454	0.801300	0.964600	0.738500	0.731900	0.953600	0.252800

(Continues)

TABLE 3 (Continued)

PSLP	Output	GEN1	GEN2	GEN3	GEN4	GEN5	GEN6	P_{WES}
9	Target output	47.317142	62.973846	19.080761	25.170880	18.615006	34.609635	9.417636
	Predicted output	47.316800	62.788000	18.938500	25.014800	18.583200	34.256800	9.313200
	% Error	0.000619	0.295200	0.745700	0.620000	0.170900	1.019400	1.108800
10	Actual output	39.501038	52.571483	15.928897	21.013017	15.540078	28.892627	8.107734
	Predicted output	39.095700	52.274900	15.928500	20.910100	15.408100	28.698700	8.014500
	% Error	1.026064	0.564100	0.002700	0.489900	0.849000	0.671300	1.149800
11	Actual output	44.475558	59.192015	17.934885	23.659268	17.497100	32.531188	9.676243
	Predicted output	44.152600	58.912000	17.854100	23.598200	17.413800	32.240300	9.633200
	% Error	0.726259	0.473100	0.450200	0.258200	0.476000	0.894100	0.444900
12	Actual output	41.752727	55.568230	16.836897	22.210828	16.425913	30.539602	8.871699
	Predicted output	41.262700	55.173300	16.656400	21.984700	16.335900	30.351500	8.768100
	% Error	1.173685	0.710700	1.072300	1.017900	0.548200	0.615900	1.167700
13	Actual output	43.888839	58.411156	17.698289	23.347156	17.266279	32.102038	9.328935
	Predicted output	43.614300	57.856800	17.555500	23.108800	17.121500	31.879000	9.315400
	% Error	0.625617	0.949100	0.806600	1.020800	0.838600	0.694600	0.144700
14	Actual output	45.775702	60.922362	18.459172	24.350894	18.008589	33.482165	9.306317
	Predicted output	45.515500	60.846500	18.376300	24.268900	17.922900	33.406500	9.222400
	% Error	0.568523	0.124600	0.449100	0.336600	0.475700	0.226100	0.902200
15	Actual output	42.035282	55.944279	16.950838	22.361136	16.537073	30.746273	9.463821
	Predicted output	41.635900	55.399400	16.823800	22.198000	16.534300	30.562800	9.398800
	% Error	0.950078	0.973900	0.749200	0.729600	0.017100	0.596900	0.686900
16	Actual output	46.447399	61.816315	18.730035	24.708211	18.272841	33.973471	8.266222
	Predicted output	46.321900	61.199900	18.676000	24.479900	18.256700	33.953000	8.205300
	% Error	0.270131	0.997200	0.288400	0.924200	0.088500	0.060400	0.736400
17	Actual output	41.310542	54.979730	16.658584	21.975602	16.251953	30.216170	8.800214
	Predicted output	41.066600	54.748600	16.545700	21.726800	16.138100	30.196100	8.749100
	% Error	0.590541	0.420300	0.677500	1.132100	0.700800	0.066500	0.580800
18	Actual output	40.326197	53.669677	16.261645	21.451969	15.864703	29.496181	9.085652
	Predicted output	39.895500	53.396000	16.072400	21.218100	15.780800	29.379000	9.061900
	% Error	1.068051	0.509900	1.163900	1.090300	0.528800	0.397400	0.261400
19	Actual output	47.276243	62.919414	19.064269	25.149123	18.598916	34.579720	9.643212
	Predicted output	46.954100	62.492500	18.872200	25.034400	18.394600	34.321100	9.626700
	% Error	0.681318	0.678400	1.007400	0.456200	1.098600	0.748000	0.170900
20	Actual output	39.644310	52.762161	15.986672	21.089231	15.596442	28.997421	9.470849
	Predicted output	39.247100	52.323800	15.932900	21.048600	15.578900	28.690800	9.399500
	% Error	1.002043	0.830900	0.336100	0.192800	0.112500	1.057500	0.753100

6 for generator rescheduling and 1 for wind energy source) have been obtained by developing cascaded Deep NN for 63 inputs.

A graphical representation of customer participation (at bus numbers 7, 8, 12, 17, 19, 21 and 30) based on predicted outputs obtained by Deep NN and actual outputs obtained by PSO-OPF for all 120 congested power system loading patterns have been shown from Figures 7–13.

Similarly, actual outputs obtained by PSO-OPF and predicted outputs obtained by Deep NN for generation rescheduling

for all conventional generators including slack bus and active power supplied by WES have been plotted and shown in Figures 14–20.

Table 2 shows seven predicted outputs (obtained by cascaded Deep NN), actual outputs (obtained by PSO-OPF) and percentage error between them for customer participation. The maximum percentage errors calculated for these are 1.1852, 1.1074, 1.1173, 1.1197, 1.1742, 1.1328 and 1.1766. Table 3 shows generation rescheduling and wind energy source based predicted outputs, actual outputs and percentage error among

the other seven estimated outputs, actual outputs and percentage error calculated between them. The maximum percentage errors for these seven estimations are 1.173685, 1.1752, 1.1639, 1.1321, 1.0986, 1.1700 and 1.1677.

It has been observed that the performance of the developed filtering module has been found quite satisfactory to the other filtering modules like classical ANN, extreme learning machine (ELM), Deep NN and probabilistic neural network for such type of imbalance data set which contains more number of epitomes in dominance class as compared to subordinate class.

It has been observed from Figures 7–20 and Tables 2 and 3 that the predicted outputs obtained by Deep NN are very near to the actual output. Precise estimations have been attained for all 120 testing power system loading patterns. However, due to limited space, the predictions only for 20 power system loading patterns have been presented in Tables 2 and 3. It is very clear from these tables that the maximum percentage error for all six generating units, wind energy source and seven receptive customers is 1.1865% which is very less and within the acceptable limit. This can be stated that the proposed approach provides an instant and ready estimation (predicted output is very near to actual output) of customer participation, generation rescheduling and active power supplied by wind energy sources for managing congestion in all types of complex and critical conditions of the deregulated power market. The presented approach of CM has not been found in the literature.

6 | CONCLUSION

This paper presents a cascaded Deep NN-based customer participation along with wind energy sources for managing congestion in the deregulated power market. The developed module is a cascade combination of an ANN-based filtering module and a Deep NN-based CM module. The filtering module is trained by a modified back propagation algorithm which filters out the congested and non-congested power system loading patterns accurately in two classes. CM module (Deep NN) predicts the incentive-based customer participation for receptive customers, generation rescheduling for all conventional generators and active power given by wind energy source (uncertainty considered) with minimum cost for all unseen power system loading patterns. Continuously varying loading conditions in the power market lead to a slower response of evolutionary algorithms because every time its process starts from initial phases while the presented cascaded Deep NN once developed and trained well, predicts the customer participation, generation rescheduling and P_{WES} almost instantaneously. Hence, the developed module provides an instant-ready solution for all power market scenarios to manage congestion even for large size and imbalance data set. The proposed CM approach enhances the operating flexibility of emerging power market operations in complex and critical scenarios. The cascaded Deep NN has been examined on IEEE 30-bus system and found better in terms of accuracy and time. Demand forecasting and the addition of photovoltaic power sources can be added to the future scope of this research

work. It can be implemented in the large-size practical power system as well.

AUTHOR CONTRIBUTIONS

A.A.: Conceptualization, Data curation, Formal analysis, Investigation, Methodology, Project administration, Resources, Software, Validation, Visualization, Writing - original draft. P.W.: Resources, Software, Supervision, Validation, Visualization, Writing - original draft, Writing - review & editing. S.N.P.: Data curation, Formal analysis, Methodology, Project administration, Resources, Software, Supervision, Validation, Visualization, Writing - original draft. L.S.: Resources, Software, Supervision, Validation, Visualization, Writing - original draft, Writing - review & editing. R.K.S.: Resources, Software, Supervision, Validation, Visualization, Writing - original draft, Writing - review & editing. B.K.: Resources, Software, Supervision, Validation, Visualization, Writing - original draft, Writing - review & editing.

ACKNOWLEDGEMENTS

The authors acknowledge the support extended by Science and Engineering Research Board (SERB); a statutory body of the Department of Science and Technology (DST), Government of India; New Delhi, India under the sponsored research project sanction order No. EEQ/2021/000177. The authors wholeheartedly thank the department of Electrical Engineering, Indian Institute of Technology (Banaras Hindu University) Varanasi, Uttar Pradesh, India, for providing the laboratory facilities to accomplish this research work smoothly.

FUNDING INFORMATION

There is no funding available for this research in any form.

CONFLICT OF INTEREST

There is no conflict of interest among the authors.

DATA AVAILABILITY STATEMENT

Data sharing is not applicable to this article as no new data were created or analyzed in this study.

ORCID

Baseem Khan  <https://orcid.org/0000-0003-3248-3433>

REFERENCES

- Narain, A., Srivastava, S.K., Singh, S.N.: Congestion management approaches in restructured power system: Key issues and challenges. *Electr. J.* 33(3), 106715 (2020)
- Srivastava, J., Yadav, N.K., Sharma, A.K.: A novel hybrid algorithm for rescheduling-based congestion management scheme in power system. *Electr. Eng.* 102(4), 1993–2010 (2020)
- Sarwar, M., Siddiqui, A.S., Jaffery, Z.A., Kothari, D.P.: Bid responsive generation rescheduling for congestion management in electricity market. *Eng. Rep.* 3(5), e12331 (2021)
- Behrangrad, M.: A review of demand side management business models in the electricity market. *Renewable Sustainable Energy Rev.* 47, 270–283 (2015)
- Alasseri, R., Tripathi, A., Rao, T.J., Sreeknath, K.J.: A review on implementation strategies for demand side management (DSM) in Kuwait through incentive-based demand response programs. *Renewable Sustainable Energy Rev.* 77, 617–635 (2017)

6. Abdi, H., Ehsan, D., Mohammadi, F.: Dynamic economic dispatch problem integrated with demand response (DEDDR) considering non-linear responsive load models. *IEEE Trans. Smart Grid.* 7(6), 2586–2595 (2015)
7. Sunagathi, S.T., Devaraj, D., Ramar, K., Thilagar, S.H.: An improved differential evolution algorithm for congestion management in the presence of wind turbine generators. *Renewable Sustainable Energy Rev.* 81, 635–642 (2018)
8. Peesapati, R., Yadav, V.K., Niranjana, K.: Flower pollination algorithm based multi-objective congestion management considering optimal capacities of distributed generations. *Energy* 147, 980–994 (2018)
9. Dadkhah, A., Behrooz, V., Miadreza, S., Catalão, J.P.: Power system flexibility improvement with a focus on demand response and wind power variability. *IET Renewable Power Gener.* 14(6), 1095–1103 (2020)
10. Chandran, V.P., Kewat, S., Singh, B.: Multi-objective control and operation of grid-connected small hydro-solar PV-battery energy storage-based distributed generation. *IET Renewable Power Gener.* 14(16), 3259–3272 (2020)
11. Jagharh, M.J.P., Mashhadi, H.R.: Structural and behavioural evaluation of renewable energy power plants' impacts on transmission network congestion using an analytical approach. *IET Renewable Power Gener.* 14(7), 1164–1173 (2020)
12. Deb, S., Sadhan, G., Arup, K.G.: Congestion management considering wind energy sources using evolutionary algorithm. *Electr. Power Compon. Syst.* 43(7), 723–732 (2015)
13. Guesmi, T., Anouar, F., Ismail, M., Badr, A., Hsan, H.A.: Chaotic Sine-Cosine algorithm for chance-constrained economic emission dispatch problem including wind energy. *IET Renewable Power Gener.* 14(10), 1808–1821 (2020)
14. Dai, X., Ying, W., Shengchun, Y., Kaifeng, Z.: IGDT-based economic dispatch considering the uncertainty of wind and demand response. *IET Renewable Power Gener.* 13(6), 856–866 (2019)
15. Prajapati, V.K., Mahajan, V.: Congestion management of power system with uncertain renewable resources and plug-in electrical vehicle. *IET Gener. Transm. Distrib.* 13(6), 927–938 (2019)
16. Zaeim-Kohan, F., Hadi, R., Doagou-Mojarrad, H.: Multi-objective transmission congestion management considering demand response programs and generation rescheduling. *Appl. Soft Comput.* 70, 169–181 (2018)
17. Tiwari, P., Mishra, M.K.: A Two-step approach for improvement of economic profit and emission with congestion management in hybrid competitive power market. *Int. J. Electr. Power Energy Syst.* 110, 548–564 (2019)
18. Salkutti, S.R.: Multi-objective based optimal transmission switching and demand response for managing congestion in hybrid power systems. *Int. J. Green Energy* 17(8), 457–466 (2020)
19. Mishra, M., Gupta, V., Chaturvedi, U., Shukla, K.K., Yampolskiy, R.V.: A study on the limitations of evolutionary computation and other bio-inspired approaches for integer factorization. *Procedia Comput. Sci.* 62, 603–610 (2015)
20. Aote, S.S., Raghuvanshi, M.M., Malik, L.: A brief review on particle swarm optimization: Limitations & future directions. *Int. J. Comput. Sci. Eng.* 14(1), 196–200 (2013)
21. Pandey, S.N., Tapaswi, S., Srivastava, L.: Integrated evolutionary neural network approach with distributed computing for congestion management. *Appl. Soft Comput.* 10(1), 251–260 (2010)
22. Chang, C.H.: Deep and shallow architecture of multilayer neural networks. *IEEE Trans. Neural Networks Learn. Syst.* 26(10), 2477–2486 (2015)
23. Agrawal, A., Pandey, S.N., Srivastava, L., Walde, P., Singh, S., Khan, B., Saket, R.K.: Hybrid deep neural network-based generation rescheduling for congestion mitigation in spot power market. *IEEE Access* 10, 29267–29276 (2022)
24. Huang, C.J., Kuo, P.H.: Multiple-input deep convolutional neural network model for short-term photovoltaic power forecasting. *IEEE Access* 7, 74822–74834 (2019)
25. Zang, H., Cheng, L., Ding, T., Cheung, K.W.Z.W., Sun, G.: Day-ahead photovoltaic power forecasting approach based on deep convolutional neural networks and meta learning. *Int. J. Electr. Power Energy Syst.* 118, 105790 (2020)
26. Chen, Y., Yan, W., Dong, Z., Su, J., Han, Z., Zhou, D., Zhao, Y., Boa, Y.: 2D Regional short-term wind speed forecast based On CNN-LSTM deep learning model. *Energy Convers. Manage.* 244, 114451 (2021)
27. Hong, Y.-Y., Taylor, J.V., Fajardo, A.C.: Locational marginal price forecasting using deep learning network optimized by mapping-based genetic algorithm. *IEEE Access* 8, 91975–91988 (2020)
28. Reka, S.S., Venugopal, P., Alhelou, H.H., Siano, P., Golshan, M.E.H.: Real time demand response modeling for residential consumers in smart grid considering renewable energy with deep learning approach. *IEEE Access* 9, 56551–56562 (2021)
29. Saeed, F., Paul, A., Ahmed, M.J., Gul, M.J.J., Hong, W.H., Seo, H.: Intelligent implementation of residential demand response using multiagent system and deep neural networks. *Concurrency Comput. Pract. Exper.* 33(22), e6168 (2021)
30. Rangachari, A., Mehrotra, K.G., Mohan, C.K., Ranka, S.: An improved algorithm for neural network classification of imbalanced training sets. *IEEE Trans. Neural Networks* 4(6), 962–969 (1993)
31. Singh, S.N., Srivastava, L., Sharma, J.: Fast voltage contingency screening and ranking using cascade neural network. *Electr. Power Syst. Res.* 53(3), 197–205 (2000)
32. Wood, A.J., et al.: *Power Generation, Operation, and Control*. 2nd ed., John Wiley and Sons, Hoboken, NJ (2013)
33. Kothari, D.P., Nagrath, I.J., Saket, R.K.: *Modern Power System Analysis*, 5th ed., McGraw Hill publication, New Delhi, India, pp. 1–850 (2022)

How to cite this article: Agrawal, A., Walde, P., Pandey, S.N., Srivastava, L., Saket, R.K., Khan, B.: Cascaded deep NN-based customer participation by considering renewable energy sources for congestion management in deregulated power markets. *IET Renew. Power Gener.* 19, 1–14 (2025).
<https://doi.org/10.1049/rpg2.12678>